



0-870-05

**COMMERCIAL VEHICLE
ULTRASONIC DETECTION SYSTEM**

**THE ULTIMATE SOLUTION FOR
ELIMINATING BLIND SPOTS**

General Information

The Ultrasonic Detection System is strictly meant as a driver aid, and the driver is still responsible for SAFE and CORRECT driving.

What is Ultrasonic Detection System?

The Ultrasonic Detection System is a modern supervisory system that uses ultrasonic technology to eliminate blind spots for commercial vehicle drivers. The functional principle is based upon the ultrasonic echo-transit time method. Each of the sensors will emit a steady intermitting ultrasonic signal. The sensors operate as both transmitters and receivers, which will receive the beamed and reflected ultrasonic signals from possible obstacles.

How does it work?

The Ultrasonic Detection System can be fitted to the FRONT, CORNER, SIDE and BACK of the vehicle. The FRONT, CORNER and SIDE system can be activated by low speed or turning indicator through an extra control module. The BACK system can be activated by engaging reverse gear. When the system is activated, the sensors will constantly scan the surroundings of the vehicle and if there is any obstacle detected, the in-cabin buzzer or display will send progressive visual and audible warnings to the driver. The driver shall then pay extra attention to the hazard area and maneuver the vehicle accordingly. The system can also be added with optional external warning alarms or warning lights so other road users in close proximity will be effectively informed of possible danger too.

Why is it better?

Compared to the traditional way of eliminating blind spots, i.e. checking mirrors for hazard area, the Ultrasonic Detection System will constantly scan the surroundings of the vehicle and send the driver both visual and audible warnings. Therefore, the driver will have more time looking ahead and checking the mirrors. In busy traffic, the surroundings can dramatically change in the blink of an eye and the system will be a great aid for the driver. Additionally, external warning alarms and warning lights will inform other road users such as cyclists and pedestrians to proactively keep distance from the vehicle and therefore avoid collision.

What is it compatible with?

The systems come with IP69K ECU box and IP68 sensors and connectors, so they are suitable for all types of commercial vehicles such as HGVs, LGVs, vans and buses. The 12/24Vdc dual voltage feature means that they can be connected to vehicles with either 12V or 24V power supply.

General Information

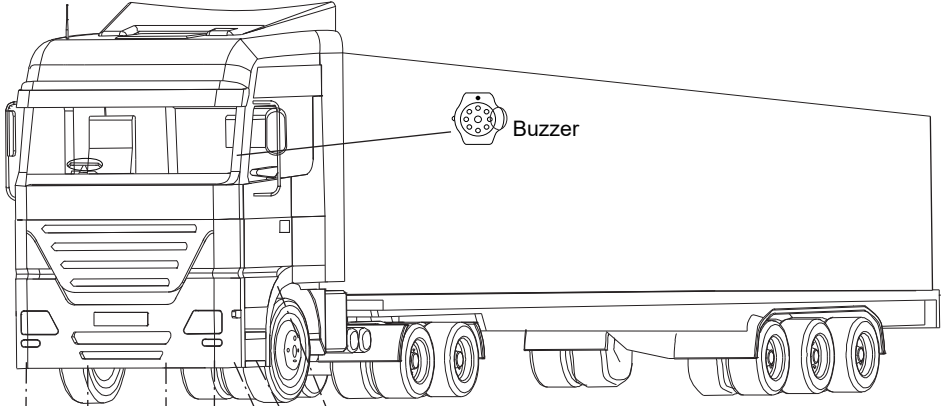

Sensors

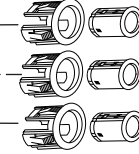
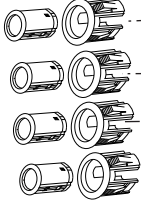

Sensors

Buzzer

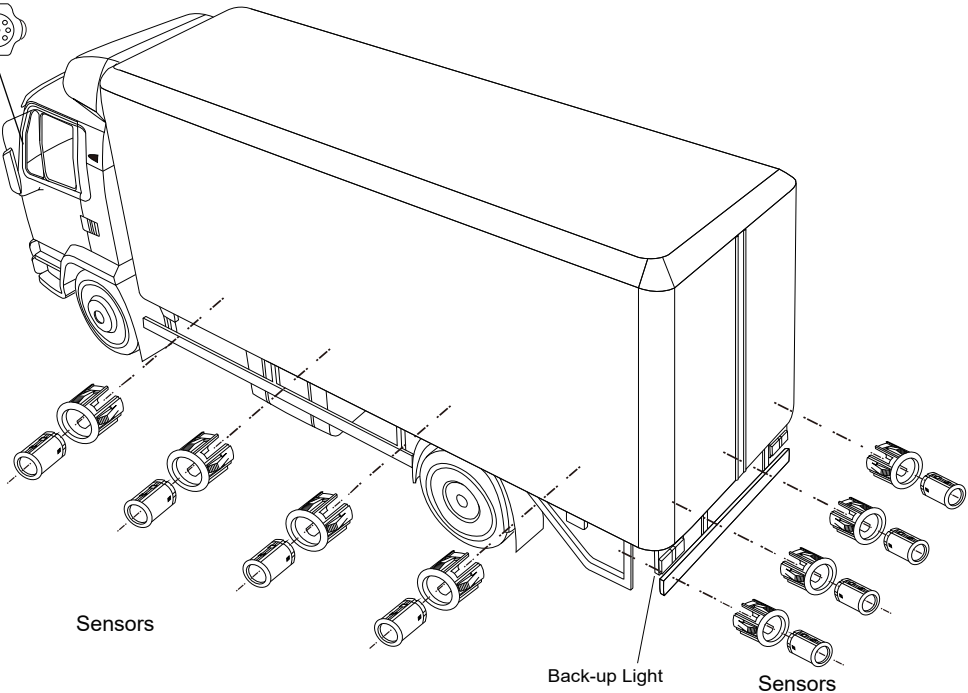

Sensors

Back-up Light

Sensors

Back Detection System 0-870-05

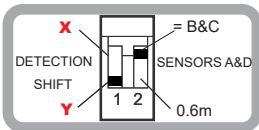
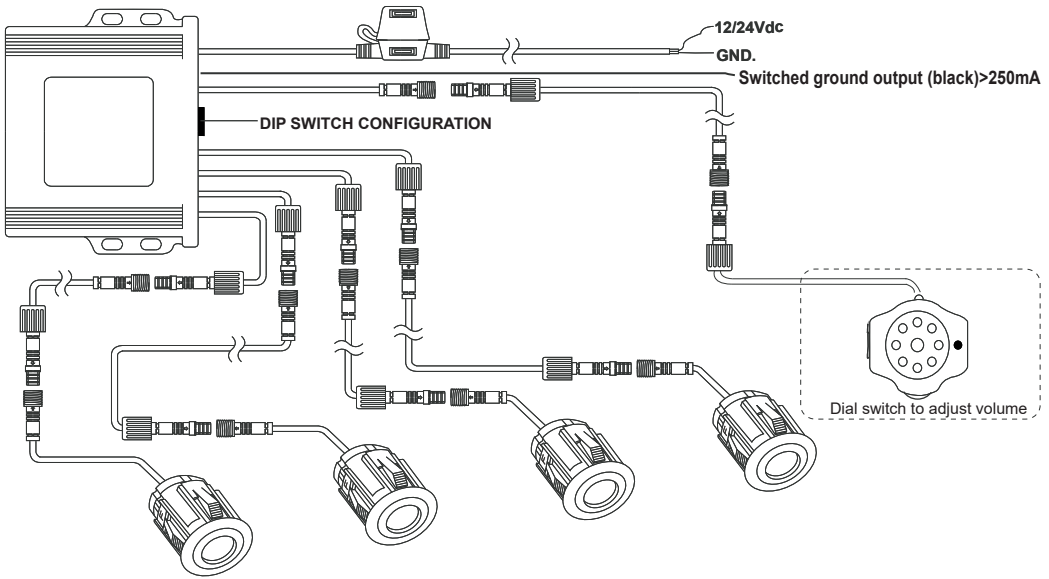

DIP SWITCH CONFIGURATION

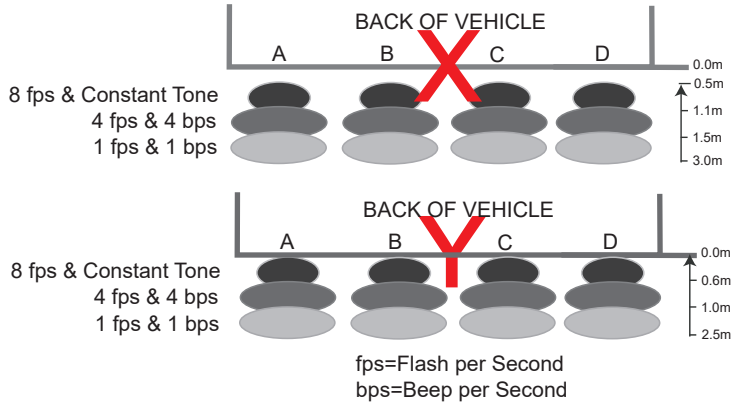

What's In The Box

- 1 X System ECU
- 1 X System Buzzer/Display
- 1 X 15m Buzzer/Display Cable
- 4 X High Sensitivity Sensor
- 4 X 2.5m Sensor Cable
- 4 X 0° Angle Sleeve
- 4 X 11° Angle Sleeve
- 4 X Underslung Bracket
- 1 X Handbook
- 1 X Accessory Kits

Sensor

Mounting height Sleeve angle

cm	°
60	-11
80	0
90	0
120	+11

Flush mount fixing

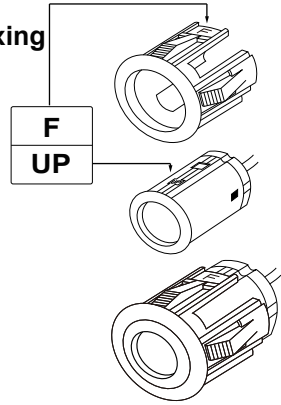

Underslung Bracket

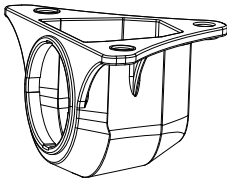

Underslung Bracket

Display/Buzzer

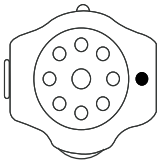

Environment Memorising Mode

1

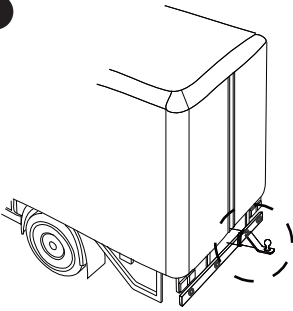

For example, if there is a tow bar, the back of truck and the system always detects it and sends false alarm.

FALSE BEEP

3

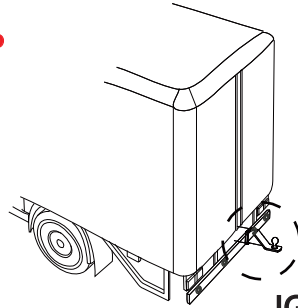

IGNORE

2 Quickly switch on and off the detection system for four times.

Then, the system will ignore the tow bar. If you want to cancel the ignore function, please also turn the key to ON 4 times.

Trouble-Shooting Guide

PROBLEM	CAUSE	SOLUTION
The system fails to start when the system is powered on	Wrong connection of power lead	Check the power lead
	Wrong jack connection	Check the connectors
The system always detects the same distance	Sensor detects the ground	Check and adjust the vertical sensor angle
The system fails to detect the obstacles	Wrong sensors connection	Check and reset the system
False alarm	Sensor detects the ground	Check and adjust the vertical sensor angle

Features

1. Latest robust sensors can detect people or ϕ 40mm pole at 2.2 meters.
2. Buzzer with audible and visual distance warning and adjustable volume control.
3. Buzzer will be mute if there is no change in detection distance for 4 seconds (for SIDE & CORNER).
4. System Self-Checking Function – The system will check all the sensors when switched on. There will be no beep if all sensors are fine; it will beep once for one faulty sensor, twice for two faulty sensors...The LED remains green throughout the self-checking process.
5. Environment Memorising Mode – System will not send false alarm caused by vehicle ancillary equipment within the first 1 meter of the detection zone.
6. Detection within 0.2s.
7. Universal sensor mounting options (through hole or underslung bracket).
8. Common components throughout Ultrasonic Detection System range.
9. Detection range adjustable by dip switch (see details for each system).

Technical Specifications

Operating Voltage	12/24Vdc
Current Consumption	200m A @ 12Vdc
Power Consumption	2.4 Watts @ 12Vdc
Buzzer Frequency	2400Hz \pm 2Khz
Buzzer Volume	72-90 \pm 5dB @30cm
Sensor Frequency	40Khz \pm 2Khz
Output Trigger For Back/Front System	250mA max
Zone Tolerance	\pm 10cm
Min Sensor Height	>40cm
Max Sensor Cable Length	10m
Casing Material	Plastic
Colour	Black
Horizontal Detection Angle	120°
Vertical Detection Angle	60°
ECU IP Rating	IP69K
Sensor And Connector IP Rating	IP68
Vibration Rating	5G
Shock Rating	10G

Special Cases

EX.1

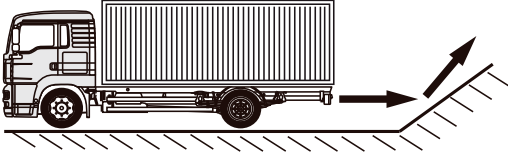

When the car approaches a smooth slope, the slope may not be detected.

EX.2

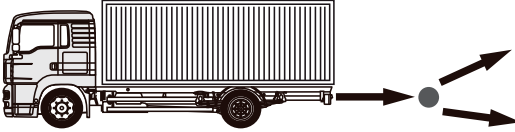

The sensors may not detect a small or smooth round pole.

EX.3

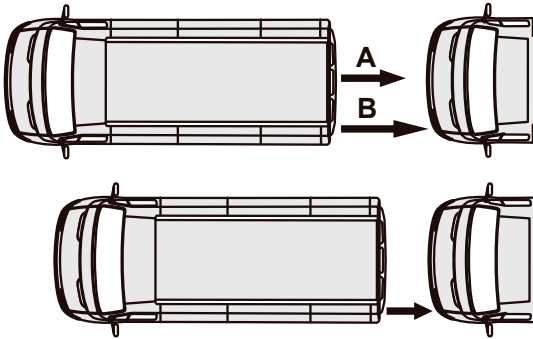

Point A will be detected prior to point B, as it comes closer.

However, point A may fall into the sensors' blind zone, and point B will be misjudged as the closest point.

EX.4

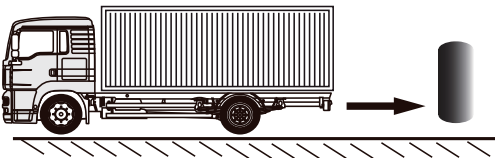

The sensors may not detect any sponge-like material obstacle as the ultrasonic wave was absorbed.

EX.5

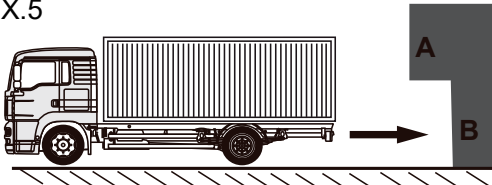

Complex situation: point A may not be detected.

IMPORTANT NOTICE

**** Carefully read the instructions and technical specifications.**



The parking sensors are an aid to vehicle reversing operations during parking. Not all objects are detected by the sensor and consequently reversing operations must be performed with the utmost care and attention.



Reversing speed must never exceed 6 km/h.



Stop the vehicle when the buzzer sounds continuously as this indicates an obstacle at not more than 30cm from the vehicle.



Perform connection operations only AFTER having disconnected the vehicle battery.



The unit must only be installed by a professional installer.



Any changes or additions made to the system and not expressly shown in this manual shall invalidate the warranty.



Clean the sensors regularly. For example, snow or dust can reduce efficiency.



In the event of washing with high-pressure water jets, the sensors could temporarily lose part of their sensitivity. This will return once the water has completely evaporated.



Do not position the unit, the sensors or the cables near heat sources such as the vehicle engine or exhaust.



Do connect the sensors firstly, and then plug the power connection. If re-connect the sensors, you **MUST** re-start the system before testing.